



BADMINTON

2015

III COPA YAWEN

Ginásio de Esportes Joana Motta

Rua Espírito Santo 1300 - Bairro Cerâmica - S.C.Sul.

São Caetano do Sul - 12 e 13 de Setembro de 2015

SÁBADO, 12 DE SETEMBRO DE 2015**III COPA YAWEN**

HORA								
08:30h								
09:00h	6smb1	6smb2	6smb3	6smb4	6smb5	13dmsi1	23dmvi1	
09:30h	28dmvii1	1sma1	1sma2	1sma3	1sma4	1sma5	1sma6	
10:00h	1sma7	1sma8	2sfa1	2sfa2	7sfb1	7sfb2	7sfb3	
10:30h	7sfb4	11smsi1	11smsi2	11smsi3	11smsi4	11smsi5	11smsi6	
11:00h	11smsi7	25dxvi1	3dma1	3dma2	6smb6	6smb8	6smb13	
11:30h	6smb7	6smb9	6smb10	6smb11	6smb12	13dmsi2	13dmsi3	
12:00h	13dmsi4	13dmsi5	13dmsi6	13dmsi7	13dmsi8		19dfsii1	
12:30h	19dfsii2	23dmvi2	28dmvii2	8dmb1	8dmb2	8dmb3	8dmb4	
13:00h	5dxa4	5dxa5	5dxa6					
13:30h	8dmb5	5dxa1	5dxa2					
14:00h	5dxa3	15dxsi1	15dxsi2					
14:30h	15dxsi3	15dxsi5	15dxsi6	15dxsi7				
15:00h	15dxsi8	10dxb1	10dxb2	15dxsi4	20dxsii1	20dxsii2	25dxvi2	13dmsi9
15:30h	2sfa3	2sfa4	2sfa5	10dxb3	12sfsi1	17sfsii1	17sfsii2	
16:00h	1sma9	1sma10	1sma11	2sfa6	7sfb5	7sfb6	7sfb7	
16:30h	7sfb8	11smsi8	11smsi9	1sma12	11smsi11	16smsii1	16smsii2	
17:00h	16smsii3	16smsii4	6smb14	11smsi10	6smb16	6smb17	21smvi1	
17:30h	21smvi2	26smvii1	3dma3	6smb15	3dma5	3dma6	4dfa1	
18:00h	4dfa2	8dmb6	8dmb7	3dma4	8dmb9	9dfb1	9dfb2	
18:30h	13dmsi10	13dmsi11	13dmsi12	8dmb8	14dfsii1	14dfsii2	18dmsii1	
19:00h	19dfsii3	19dfsii4	23dmvi3	13dmsi13	5dxa7	5dxa8	5dxa9	
19:30h	5dxa10	10dxb4	10dxb5	28dmvii3	10dxb7	15dxsi9	15dxsi10	
20:00h	15dxsi11	15dxsi12	20dxsii3	10dxb6	25dxvi3	20dxsii4		

DOMINGO, 13 DE SETEMBRO DE 2015**III COPA YAWEN**

HOR								
08:00h								
08:30h								
09:00h	6smb18	6smb19	7sfb9	7sfb10	11smsi12	11smsi13	17sfsii3	
09:30h	1sma13	1sma14	2sfa7	2sfa8	16smsii5	16smsii6	17sfsii4	
10:00h	8dmb10	8dmb11	9dfb3	9dfb4	13dmsi14	13dmsi15	14dfsii3	
10:30h	3dma7	3dma8	4dfa3	4dfa4	14dfsii4	18dmsii2	18dmsii3	
11:00h	10dxb8	10dxb9	21smvi3	21smvi4	26smvii2	26smvii3		
11:30h	5dxa11	5dxa12	15dxsi13	15dxsi14				
12:00h	10dxb10							
12:30h	5dxa13		13dmsi16	18dmsii4	18dmsii5	14dfsii5	14dfsii6	
13:00h	8dmb12	9dfb5	9dfb6					
13:30h	3dma9	4dfa5	4dfa6	15dxsi15				
14:00h	6smb20	7sfb11	11smsi14	26smvii4	26smvii5	21smvi5	21smvi6	
14:30h	1sma15	2sfa9	16smsii7	17sfsii5	17sfsii6			

III COPA YAWEN - 2015

SMA

1

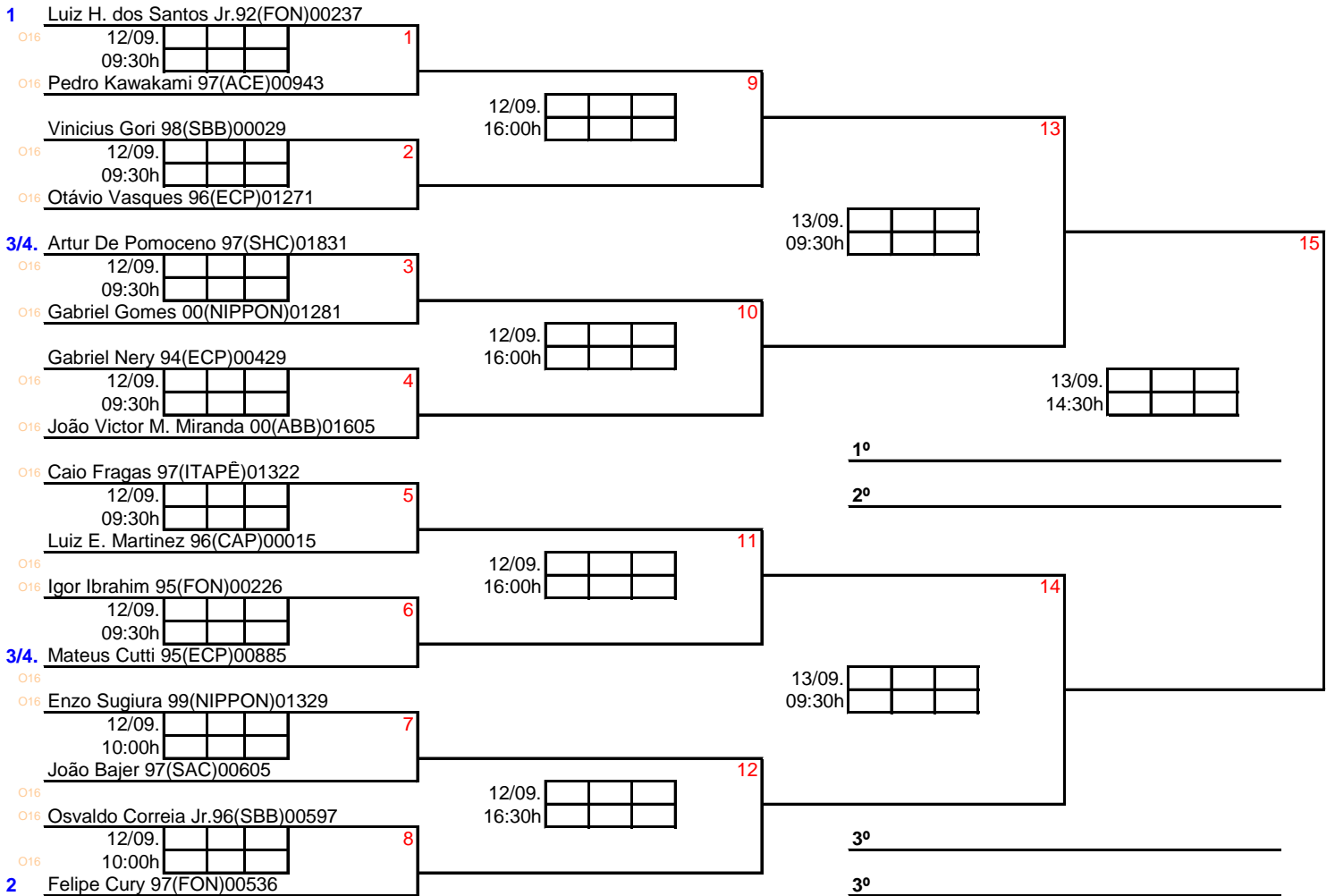

III COPA YAWEN - 2015

SFA

2

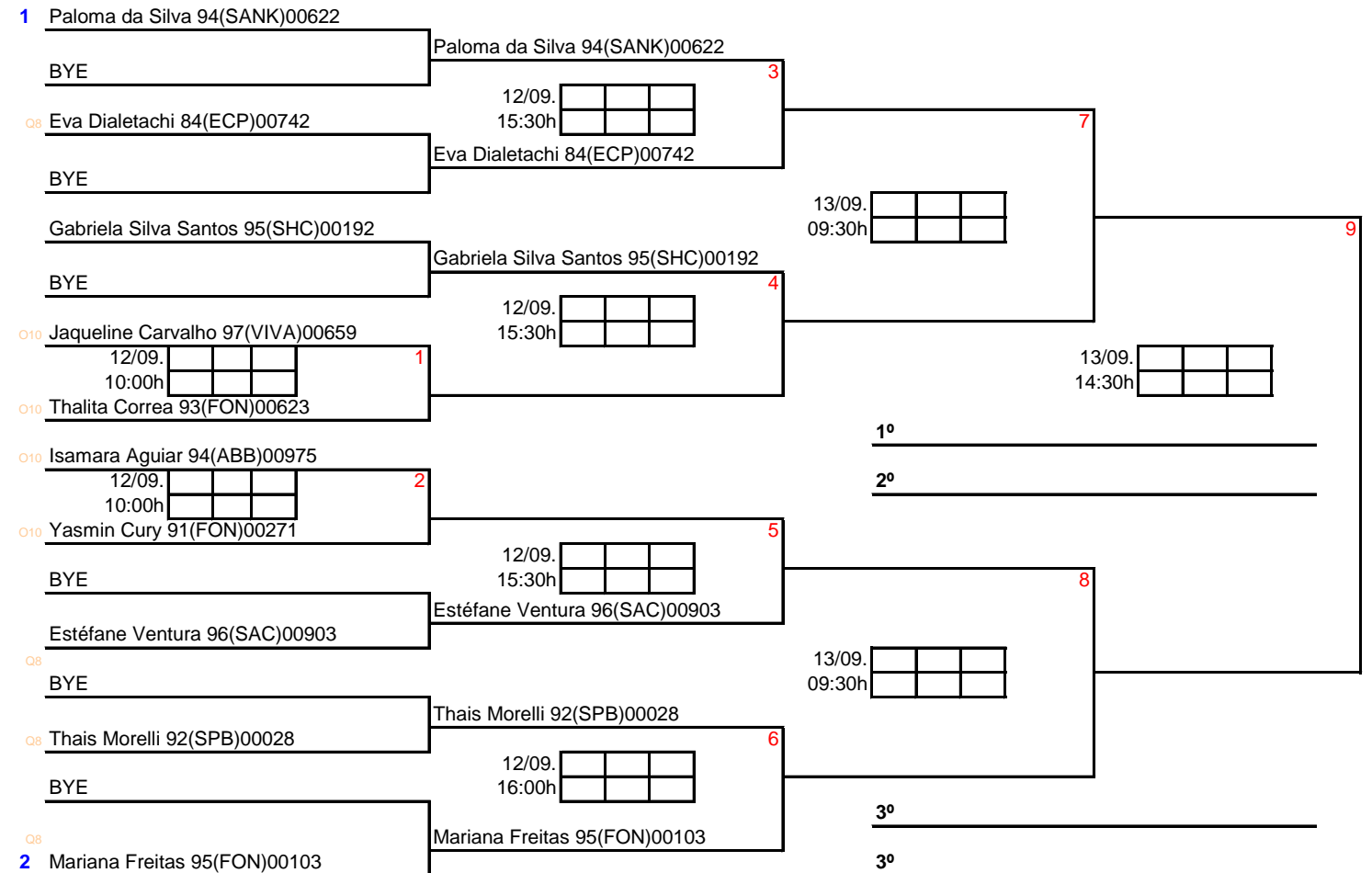

08 Leonardo Alkimin 94(FON)

1 Luiz H. dos Santos Jr.92(FON)00237

BYE

Leonardo Alkimin 94(FON)
Luiz H. dos Santos Jr.92(FON)00237

12/09.

17:30h

3

08 Caio Fragas 97(ITAPÊ)01322
João Victor M. Miranda 00(ABB)01605

BYE

Caio Fragas 97(ITAPÊ)01322
João Victor M. Miranda 00(ABB)01605

13/09.

10:30h

7

08 Artur De Pomoceno 97(SHC)01831
Gustavo Pereira 95(SHC)00768

BYE

Artur De Pomoceno 97(SHC)01831
Gustavo Pereira 95(SHC)00768

12/09.

18:00h

4

010 João Bajer 97(SAC)00605
Pedro Kawakami 97(ACE)00943

BYE

12/09.

11:00h

1

12/09.

18:00h

13/09.

13:30h

010 Filipe Toledo 87(ECP)00168
Mateus Cutti 95(ECP)00885

1º

010 Masayasu Okada 80(AVL)
Osamu Katsuyama 77(AVL)

BYE

12/09.

11:00h

2

12/09.

17:30h

5

2º

010 Enzo Sugiura 99(NIPPON)01329
Gabriel Gomes 00(NIPPON)01281

BYE

Gabriel Nery 94(ECP)00429
Otávio Vasques 96(ECP)01271

8

08 Gabriel Nery 94(ECP)00429
Otávio Vasques 96(ECP)01271

BYE

13/09.

10:30h

08 Osvaldo Correia Jr.96(SBB)00597
Vinicius Gori 98(SBB)00029

BYE

Osvaldo Correia Jr.96(SBB)00597
Vinicius Gori 98(SBB)00029

6

12/09.

17:30h

3º

08 Igor Ibrahim 95(FON)00226
2 Felipe Cury 97(FON)00536

BYE

Igor Ibrahim 95(FON)00226
Felipe Cury 97(FON)00536

3º

- 4 Marta Lopes 77(SANK)00196
- 1 Paloma da Silva 94(SANK)00622

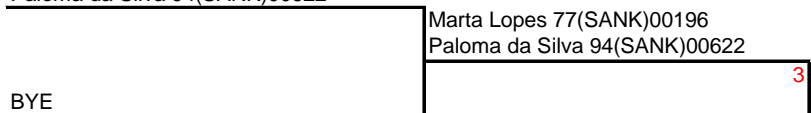

13/09.

10:30h

- 06 Yasmin Cury 91(FON)00271
- Mariana Freitas 95(FON)00103

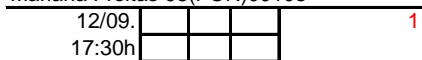

12/09.

17:30h

- 06 Gabriela Silva Santos 95(SHC)00192
- Jaqueline Carvalho 97(VIVA)00659

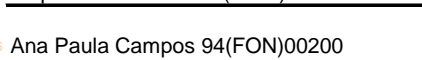

13/09.

13:30h

- 06 Ana Paula Campos 94(FON)00200
- Thalita Correa 93(FON)00623

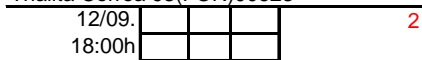

12/09.

18:00h

- 06 Estéfane Ventura 96(SAC)00903
- Mariana Couto 98(SAC)00905

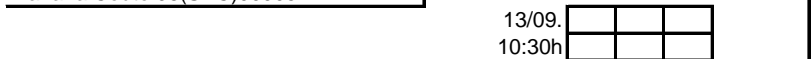

13/09.

10:30h

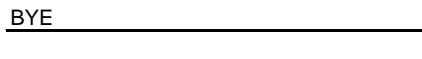

- 4 Isamara Aguiar 94(ABB)00975
- 2 Thais Morelli 92(SPB)00028



13/09.

13:30h

4º

08 João Bajer 97(SAC)00605

1 Estéfane Ventura 96(SAC)00903

BYE

João Bajer 97(SAC)00605
Estéfane Ventura 96(SAC)00903

7

12/09.

19:00h

014 Gabriel Nery 94(ECP)00429

Eva Dialetachi 84(ECP)00742

12/09.

13:30h

1

014 Igor Ibrahim 95(FON)00226

Yasmin Cury 91(FON)00271

014 Felipe Cury 97(FON)00536

Mariana Freitas 95(FON)00103

12/09.

13:30h

2

014 Osvaldo Correia Jr.96(SBB)00597

Manoela Gori 00(SBB)00493

12/09.

19:00h

8

014 Gabriel Gomes 00(NIPPON)01281

Vladia Kaida 80(NIPPON)01770

12/09.

14:00h

3

014 João Victor M. Miranda 00(ABB)01605

Isamara Aguiar 94(ABB)00975

13/09.

11:30h

13

014 Lioiti Takasaki 78(SPB)01423

Thais Morelli 92(SPB)00028

12/09.

13:00h

4

014 Gustavo Pereira 95(SHC)00768

Jaqueline Carvalho 97(VIVA)00659

12/09.

19:00h

9

014 Luiz H. dos Santos Jr.92(FON)00237

Ana Paula Campos 94(FON)00200

12/09.

13:00h

5

014 Mateus Cutti 95(ECP)00885

Paloma da Silva 94(SANK)00622

13/09.

11:30h

13/09.

12:30h

1º

2º

12

014 Artur De Pomoceno 97(SHC)01831

Marta Lopes 77(SANK)00196

12/09.

13:00h

6

014 Vinicius Gori 98(SBB)00029

Mariana Couto 98(SAC)00905

12/09.

19:30h

10

BYE

Leonardo Alkimin 94(FON)
Thalita Correa 93(FON)00623

3º

08 Leonardo Alkimin 94(FON)

2 Thalita Correa 93(FON)00623

3º

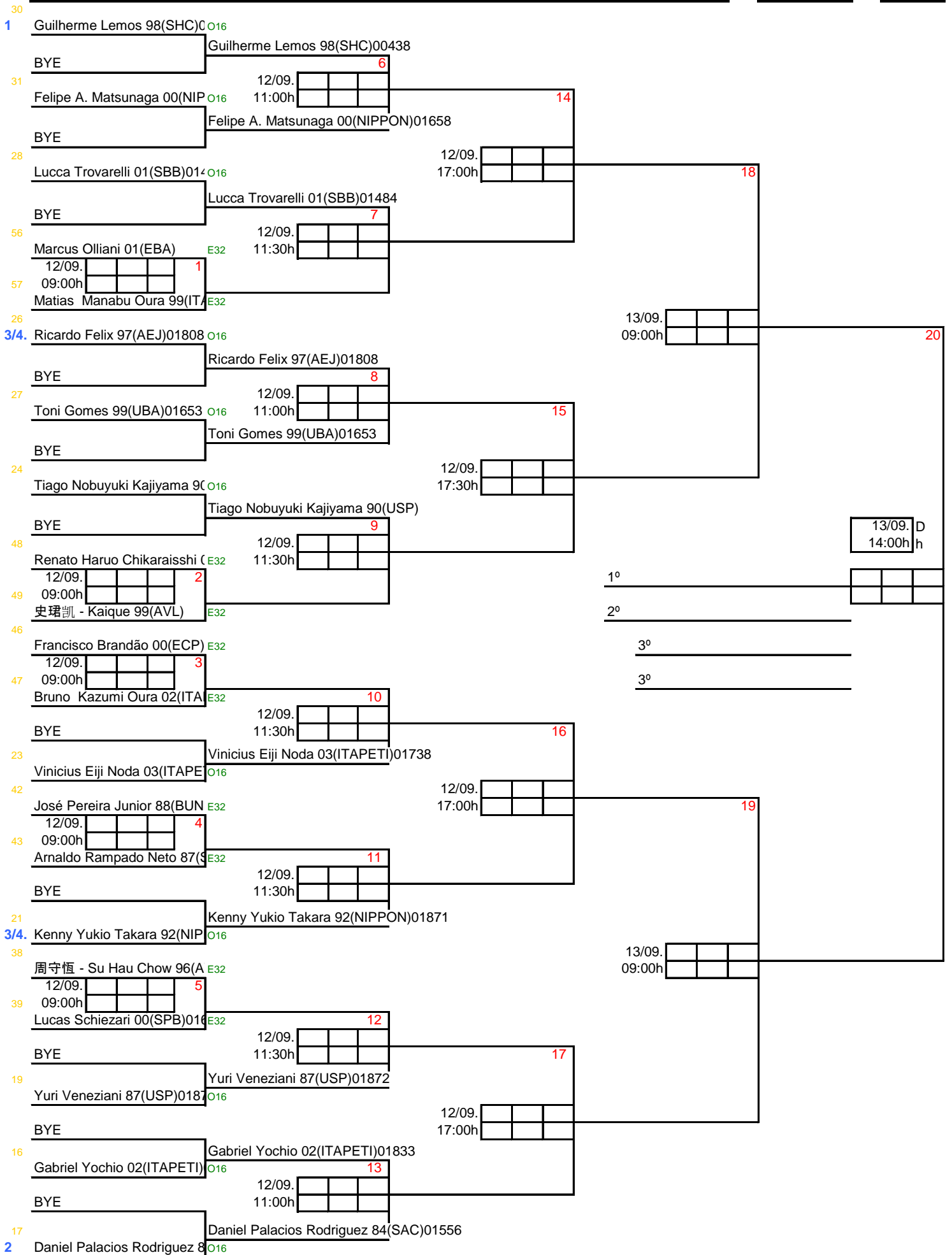

1 Rayssa Lopes 00(UBA)01659

Q8
BYE
Rayssa Lopes 00(UBA)01659 5
12/09. [][][]
16:00h [][][]

O12 Geisa Oliveira 03(NEUSA)01368 1
12/09. [][][]
10:00h [][][]

O12 Fernanda Lie Matsunaga 04(NIPPON)01662

Manoela Gori 00(SBB)00493

Q8
BYE
Manoela Gori 00(SBB)00493 6
12/09. [][][]
16:00h [][][]

O12 Sofia Alonso 04(ECP)01642 2
12/09. [][][]
10:00h [][][]

O12 陈家蕊 - Veronica Chen 99(AVL)

O12 Milene Pereira 01(AEJ)01807 3
12/09. [][][]
10:00h [][][]

O12 Maria Luiza Silva 01(UBA)01664

BYE
12/09. [][][]
16:00h [][][] 7

Q8 刘念 - Raquel Liu 88(AVL)

O12 徐佩霜 - Xu Pei Shuang 87(AVL) 4
12/09. [][][]
10:30h [][][]

O12 Ana Beatriz de Souza 00(SBB)01366

BYE
12/09. [][][]
16:30h [][][] 8

Q8 2 Andreia R. da Rocha 87(USP)01820 3°

13/09. [][][]
09:00h [][][]

13/09. [][][]
14:00h [][][]

1°

2°

13/09. [][][]
09:00h [][][]

3°

3°

11

10

08 Leonardo Scheffer 85(UBA)01665

1 Toni Gomes 99(UBA)01653

Leonardo Scheffer 85(UBA)01665
Toni Gomes 99(UBA)01653

BYE

12/09.

18:00h

6

013 Bruno Souza Carmo 80(USP)00930
Yuri Veneziani 87(USP)01872

12/09.

12:30h

1

013 Aron Kim 97(AVL)
皇甫石哲 - Huang Fu Shi Zhe 87(AVL)

13/09.

10:00h

10

08 Edgar Koji Ogawa 77(NIPPON)
Kenny Yukio Takara 92(NIPPON)01871

BYE

Edgar Koji Ogawa 77(NIPPON)
Kenny Yukio Takara 92(NIPPON)01871

12/09.

18:00h

7

013 Gabriel Yochio 02(ITAPETI)01833
Renato Haruo Chikaraisshi 03(ITAPETI)01765

12/09.

12:30h

2

013 Gabriel B. Costa 90(AVL)
William Ap. Silva 86(AVL)

13/09.

13:00h

12

013 Denis Simabucuro 67(SPB)01686
Lucas Schiezari 00(SPB)01648

12/09.

12:30h

3

013 Felipe A. Matsunaga 00(NIPPON)01658
Matias Manabu Oura 99(ITAPETI)01495

12/09.

18:30h

8

013 Arthur Lemos Jr. 66(SHC)00481
Guilherme Lemos 98(SHC)00438

12/09.

12:30h

4

013 Arthur Spada 90(BUNKA)01636
Celso Spada 66(BUNKA)01626

13/09.

10:00h

11

013 Bruno Kazumi Oura 02(ITAPETI)01494
Vinicius Eiji Noda 03(ITAPETI)01738

12/09.

13:30h

5

013 Arnaldo Rampado Neto 87(SBB)01898
Daniel Palacios Rodriguez 84(SAC)01556

12/09.

18:00h

9

BYE

Diogo José de Sousa Silva 86(USP)01819
Gerhard Wunderlich 63(USP)01782

1º

2º

3º

3º

08 Diogo José de Sousa Silva 86(USP)01819
2 Gerhard Wunderlich 63(USP)01782

4 Rayssa Lopes 00(UBA)01659

1 Maria Luiza Silva 01(UBA)01664

BYE

Rayssa Lopes 00(UBA)01659
 Maria Luiza Silva 01(UBA)01664

3

13/09.

 10:00h

06 Andreia R. da Rocha 87(USP)01820
 Clarissa J. Ferreira 83(USP)00434

12/09.

 18:00h

1

06 Angela Helen Liu 96(AVL)
 徐佩霜 - Xu Pei Shuang 87(AVL)

13/09.

 13:00h

5

1º

06 Geisa Oliveira 03(NEUSA)01368
 Sofia Alonso 04(ECP)01642

12/09.

 18:00h

2

06 Isabella Mei Noda 06(ITAPETI)01737
 Fernanda Lie Matsunaga 04(NIPPON)01662

13/09.

 10:00h

4

2º

BYE

林颖 - Lin Ying 75(AVL)
 刘念 - Raquel Liu 88(AVL)

4 林颖 - Lin Ying 75(AVL)
 刘念 - Raquel Liu 88(AVL)

13/09.

 13:00h

6 3º

4º

08 Diogo José de Sousa Silva 86(USP)01819

1 Andreia R. da Rocha 87(USP)01820

Diogo José de Sousa Silva 86(USP)01819
 Andreia R. da Rocha 87(USP)01820

BYE

12/09.

 19:30h

4

08 张炆奎 - Zhang Yankui 84(AVL)
 Angela Helen Liu 96(AVL)

张炆奎 - Zhang Yankui 84(AVL)
 Angela Helen Liu 96(AVL)

BYE

13/09.

 11:00h

8

08 Ricardo Felix 97(AEJ)01808
 Milene Pereira 01(AEJ)01807

Ricardo Felix 97(AEJ)01808
 Milene Pereira 01(AEJ)01807

BYE

12/09.

 19:30h

5

13/09.

 11:00h

10

011 李韬 - Taylor Li 81(AVL)
 徐佩霜 - Xu Pei Shuang 87(AVL)

12/09.

 15:00h

1

011 Toni Gomes 99(UBA)01653
 Rayssa Lopes 00(UBA)01659

13/09.

 12:00h

1º

011 Gabriel Enzo Murai 03(BUNKA)01894
 Fernanda Lie Matsunaga 04(NIPPON)01662

12/09.

 15:00h

2

011 Francisco Brandão 00(ECP)00848
 Aline Brasil 99(ECP)

12/09.

 20:00h

6

2º

BYE

邵赫超 - Shao He Chao 85(AVL)
 刘念 - Raquel Liu 88(AVL)

08 邵赫超 - Shao He Chao 85(AVL)
 刘念 - Raquel Liu 88(AVL)

13/09.

 11:00h

9

011 Rafael Cabral 04(SHC)01467
 Sofia Alonso 04(ECP)01642

12/09.

 15:30h

3

011 周守恆 - Su Hau Chow 96(AVL)
 陈家蕊 - Veronica Chen 99(AVL)

12/09.

 19:30h

7

3º

BYE

Leonardo Scheffer 85(UBA)01665
 Maria Luiza Silva 01(UBA)01664

08 Leonardo Scheffer 85(UBA)01665
 2 Maria Luiza Silva 01(UBA)01664

3º

1 Vinod Kurup 69(ACE)01326

Vinod Kurup 69(ACE)01326

BYE

12/09.
16:30h

8

Sérgio Massaru Niigaki 84 (NIPPON)

12/09.
10:30h

1

12

Fábio Macedo Mei 76(ECP)01789

Pedro Lanas 79(SAC)00687

12/09.
10:30h

2

13/09.
09:00h

14

Walker 77(AVL)

12/09.
16:30h

9

Thiago de Faria 85(USP)01783

12/09.
10:30h

3

13/09.
14:00h

张场奎 - Zhang Yankui 84(AVL)

1º

2º

Roberto Kaida 80(NIPPON)01769

12/09.
10:30h

4

Tiago Ranalli 85(ECP)

12/09.
17:00h

10

13

Leonardo Scheffer 85(UBA)01665

12/09.
10:30h

5

13/09.
09:00h

邵赫超 - Shao He Chao 85(AVL)

Bruno Souza Carmo 80(USP)00930

12/09.
10:30h

6

Marcos Pedro Oliveira 67(AVL)

12/09.
16:30h

11

3º

3º

Alexandre Turci 77(AVL)

12/09.
11:00h

7

2 Lioiti Takasaki 78(SPB)01423

Isuzu Matsuda 76(SPB)01650

12/09.
15:30h

1

Clarissa J. Ferreira 83(USP)00434

CLASSIFICAÇÃO FINAL

1º
2º

35 Fábio Moreira 62(ECP)00187
Pedro Lanas 79(SAC)00687 E32

Fábio Moreira 62(ECP)00187
Pedro Lanas 79(SAC)00687

BYE

2

12/09.

11:30h		

36 王林 - Wang Li 85(AVL)
张杨奎 - Zhang Yankui 84(A) E32

王林 - Wang Li 85(AVL)
张杨奎 - Zhang Yankui 84(AVL)

BYE

10

37 Fábio Macedo Mei 76(ECP)01789
Tiago Ranalli 85(ECP) E32

Fábio Macedo Mei 76(ECP)01789
Tiago Ranalli 85(ECP)

BYE

3

12/09.

11:30h		

38 Hae Ung Lee 80(AVL)
许明林 - MingLin xu 75(AVL) E32

Hae Ung Lee 80(AVL)
许明林 - MingLin xu 75(AVL)

BYE

39 Eder Cruz 69(CAP)00186
Lioiti Takasaki 78(SPB)0142 E32

Eder Cruz 69(CAP)00186
Lioiti Takasaki 78(SPB)01423

BYE

4

12/09.

12:00h		

40 Helio Ribeiro 81(AVL)
李韬 - Taylor Li 81(AVL) E32

Helio Ribeiro 81(AVL)
李韬 - Taylor Li 81(AVL)

BYE

11

41 吕广 - Lyu Guang 79(AVL)
Walker 77(AVL) E32

吕广 - Lyu Guang 79(AVL)
Walker 77(AVL)

BYE

5

12/09.

12:00h		

42 Paulo Kang 80(AVL)
Song Sil Park 82(AVL) E32

Paulo Kang 80(AVL)
Song Sil Park 82(AVL)

BYE

12/09.

18:30h		

14

13/09.

10:00h		

16

13/09. D
12:30h

1°

2°

3°

46 Eliandro Mateus do Santos 71(SBB)01886

Henrique Utino 81(AVL) E32

12/09.

			1
--	--	--	---

09:00h

47 戴凯伟 - Dai Kai Wei 83(AVL)

王忠强 - Daniel 85(AVL) E32

12/09.

			6
--	--	--	---

12:00h

BYE

Alexandre Omura 72(ECP)00495
Vinod Kurup 69(ACE)01326

43 Alexandre Omura 72(ECP)00495

Vinod Kurup 69(ACE)01326 E32

12/09.

			12
--	--	--	----

18:30h

BYE

Edson Corretori 70(BUNKA)01701
Gerson Cellotto 71(BUNKA)

44 Edson Corretori 70(BUNKA)01701

Gerson Cellotto 71(BUNKA) E32

12/09.

			7
--	--	--	---

12:00h

BYE

陈炳强 - Chen Bing Qiang 71(AVL)
王祥华 - Wang Xiang Hua 77(AVL)

45 陈炳强 - Chen Bing Qiang 71(AVL)

王祥华 - Wang Xiang Hua 77(AVL) E32

13/09.

			15
--	--	--	----

10:00h

BYE

姜永东 - Jiang Yong Dong 70(AVL)
刘亦杰 - Liu Yijie 78(AVL)

48 姜永东 - Jiang Yong Dong 70(AVL)

刘亦杰 - Liu Yijie 78(AVL) E32

12/09.

			8
--	--	--	---

12:00h

BYE

Eduardo Banno 74(BUNKA)01870
Willian Kanashiro Chan 73(BUNKA)01895

49 Eduardo Banno 74(BUNKA)01870

Willian Kanashiro Chan 73(BUNKA)01895 E32

13/09.

			13
--	--	--	----

19:00h

BYE

项志华 - Xiang ZhiHua 78(AVL)
赵桂才 - Zhao Gui Cai 67(AVL)

50 项志华 - Xiang ZhiHua 78(AVL)

赵桂才 - Zhao Gui Cai 67(AVL) E32

12/09.

			9
--	--	--	---

15:00h

BYE

Felipe Faria Cunha 75(SPB)01722
Roberto Kaida 80(NIPPON)01769

51 Felipe Faria Cunha 75(SPB)01722

Roberto Kaida 80(NIPPON)01769 E32

3°

4 Cleonice Jesus Santos 78(SBB)01424
 Elisabete Ap. Rodrigues 80(SBB)01407

Cleonice Jesus Santos 78(SBB)01424
 Elisabete Ap. Rodrigues 80(SBB)01407

BYE

13/09.

 10:00h

3

06 Patricia Fumie Egima 77(BUNKA)01736
 Rita Corretori 71(BUNKA)01702

12/09.

 18:30h

1

06 Agnes Yumi Noda 78(ITAPETI)01800
 Isuzu Matsuda 76(SPB)01650

13/09.

 12:30h

5

1º

06 李宝琪 - Li Bao Qi 78(AVL)
 张东善 - Zhang DongShan 73(AVL)

12/09.

 18:30h

2

06 Sandra Harumi I. Agena 79(NIPPON)
 Uli Mirella Zago 82(BUNKA)

13/09.

 10:30h

4

2º

BYE

Patricia Alonso 76(SPB)01691
 Vladia Kaida 80(NIPPON)01770

4 Patricia Alonso 76(SPB)01691
 Vladia Kaida 80(NIPPON)01770

13/09.

 12:30h

6 3º

4º

016 Ricardo Moro Costa 72(AABB)01560 Elisabete Ap. Rodrigues 80(SBB)01407 12/09. [][][] 1 14:00h [][][]			
016 Roberto Kaida 80(NIPPON)01769 Katia Ishiyama 75(NIPPON)	12/09. [][][] 9 19:30h [][][]		
016 Denis Simabucuro 67(SPB)01686 Isuzu Matsuda 76(SPB)01650 12/09. [][][] 2 14:00h [][][]		13/09. [][][] 13 11:30h [][][]	
016 王祥华 - Wang Xiang Hua 77(AVL) 林颖 - Lin Ying 75(AVL)			
016 刘亦杰 - Liu Yijie 78(AVL) 杨鸿 - Yang Hong 75(AVL) 12/09. [][][] 3 14:30h [][][]			15
016 Henrique Utino 81(AVL) Cleonice Jesus Santos 78(SBB)01424 12/09. [][][] 10 19:30h [][][]			
016 Alexandre Omura 72(ECP)00495 Sandra Harumi I. Avena 79(NIPPON) 12/09. [][][] 4 15:00h [][][]		13/09. [][][] 13:30h [][][]	
016 Willian Kanashiro Chan 73(BUNKA)01895 Patricia Fumie Egima 77(BUNKA)01736		1°	
016 梁毅 - Liang yi 81(AVL) 关林瑶 - Guan Lin Yao 82(AVL) 12/09. [][][] 5 14:30h [][][]		2°	
016 Adriano Alonso 70(SPB)01690 Patricia Alonso 76(SPB)01691 12/09. [][][] 11 20:00h [][][]			
016 Paulo Kang 80(AVL) 张东善 - Zhang DongShan 73(AVL) 12/09. [][][] 6 14:30h [][][]		14	
016 Sérgio Massaru Niigaki 84 (NIPPON) Geny Fragas 65(ITAPÉ)01325		13/09. [][][] 11:30h [][][]	
016 Edson Corretori 70(BUNKA)01701 Uli Mirella Zago 82(BUNKA) 12/09. [][][] 7 14:30h [][][]			
016 Alexandre Turci 77(AVL) Daniela Federico 76(AVL) 12/09. [][][] 12 20:00h [][][]		3°	
016 Alexandre Levine 68(USP)01567 Clarissa J. Ferreira 83(USP)00434 12/09. [][][] 8 15:00h [][][]		3°	
016 程永强 - Cheng Yong Qiang 74(AVL) 李宝琪 - Li Bao Qi 78(AVL)			

1 Alexandre Omura 72(ECP)00495 08 12/09. [][][] 1 16:30h [][][]			
08 Ed Wilson Barbosa 67(AJS)01318 陈炳强 - Chen Bing Qiang 71(AVL) 08 12/09. [][][] 2 16:30h [][][]	13/09. [][][] 5 09:30h [][][]		
08 Eliandro Mateus do Santos 71(SBB)01886		13/09. [][][] 7 14:30h [][][]	10
08 Felipe Faria Cunha 75(SPB)01722 Paulo Sergio Cruz 68(ACE)01098 08 12/09. [][][] 3 17:00h [][][]			2°
08 Alberto Bro 67(AVL) 08 12/09. [][][] 4 17:00h [][][]	13/09. [][][] 6 09:30h [][][]		3°
2 Alexandre Levine 68(USP)01567			3°

1 Luciana Mendonça 70(SBB)00032

Luciana Mendonça 70(SBB)00032

BYE

13/09.

Geny Fragas 65(ITAPÉ)01325

12/09.

15:30h

林颖 - Lin Ying 75(AVL)

Débora Silva Carvalho 67(SBB)01406

12/09.

15:30h

Yoshiko Kawai 53(ACE)01328

BYE

13/09.

09:30h

Lucilia Rodrigues 68(SPB)01731

2 Lucilia Rodrigues 68(SPB)01731

13/09.

14:30h

13/09.

14:30h

4 陈永春 - Chen Yong Chun 65(AVL)

程永强 - Cheng Yong Qiang 74(AVL)

陈永春 - Chen Yong Chun 65(AVL)

程永强 - Cheng Yong Qiang 74(AVL)

BYE

13/09.

10:30h

4 Nelson Pozzi 67(BUNKA)01563

Reginaldo Tamayose 68(BUNKA)01869

Nelson Pozzi 67(BUNKA)01563

Reginaldo Tamayose 68(BUNKA)01869

BYE

05 Andre Luiz Teixeira 75(ACE)00958

Paulo Sergio Cruz 68(ACE)01098

12/09.

18:30h

05 Ed Wilson Barbosa 67(AJS)01318

Ricardo Moro Costa 72(AABB)01560

13/09.

10:30h

BYE

黄吟瀛 - Huang YinYing 71(AVL)

杨勇 - Yang Yong 74(AVL)

4 黄吟瀛 - Huang YinYing 71(AVL)

杨勇 - Yang Yong 74(AVL)

13/09.

12:30h

III COPA YAWEN - 2015

DFS II

19

4 Michele Sun 68(AVL)

Selma Evangelista 60(SBB)00076

12/09.

12:00h

1

4 Geny Fragas 65(ITAPÉ)01325

Lucilia Rodrigues 68(SP)01731

12/09.

19:00h

1°

4 Débora Silva Carvalho 67(SBB)01406

Luciana Mendonça 70(SBB)00032

12/09.

12:30h

2

2°

4 Alice Hatsumi Kajita 54(ITAPETI)

Yoshiko Kawai 53(ACE)01328

12/09.

19:00h

3°

4°

III COPA YAWEN - 2015

DXS II

20

4 李季季 - Lie Tie Tie 54(AVL)

1 Luciana Mendonça 70(SBB)00032

12/09.

15:00h

1

4 许明林 - MingLin xu 75(AVL)

Joana 73(AVL)

12/09.

20:00h

1°

4 Nelson Pozzi 67(BUNKA)01563

Rita Corretori 71(BUNKA)01702

12/09.

15:00h

2

2°

4 Felipe Faria Cunha 75(SP)01722

Lucilia Rodrigues 68(SP)01731

12/09.

20:00h

3°

4°

III COPA YAWEN - 2015

SMV I

21

1 Fábio Moreira 62(ECP)00187

4

BYE

Fábio Moreira 62(ECP)00187

13/09.

11:00h

3

宋远雄 - Song Yuan Xiong 63(AVL)

12/09.

17:00h

1

5

06

06 Takashi Itagaki 59(ITAPETI)01404

13/09.

14:00h

1°

06 陈永春 - Chen Yong Chun 65(AVL)

12/09.

17:30h

2

2°

Roberto Miyahira 60(NIPPON)01861

13/09.

11:00h

4

06

BYE

Gerhard Wunderlich 63(USP)01782

2 Gerhard Wunderlich 63(USP)01782

13/09.

14:00h

3°

4°

1°

1°

2°

3°

4°

III COPA YAWEN - 2015

DMV I

23

Chu Shi Chung 63(AVL)

Paulo Fam 61(AVL)

12/09.

09:00h

陈青 - Chen Qing 55(AVL)

宋远雄 - Song Yuan Xiong 63(AVL)

Paulo Nishida 53(NIPPON)01862

Roberto Miyahira 60(NIPPON)01861

12/09.

19:00h

Chu Shi Chung 63(AVL)

Paulo Fam 61(AVL)

CLASSIFICAÇÃO FINAL

1 1º

2 2º

3 3º

陈青 - Chen Qing 55(AVL)

宋远雄 - Song Yuan Xiong 63(AVL)

12/09.

12:30h

Paulo Nishida 53(NIPPON)01862

Roberto Miyahira 60(NIPPON)01861

III COPA YAWEN - 2015

DXV I

25

Gerhard Wunderlich 63(USP)01782

Yoshiko Kawai 53(ACE)01328

12/09.

11:00h

Mário Augelli 53(USP)

Selma Evangelista 60(SBB)00076

李宪翔 - Li Xian Xiang 57(AVL)

顾韵 - Gu Yun 61(AVL)

12/09.

20:00h

Gerhard Wunderlich 63(USP)01782

Yoshiko Kawai 53(ACE)01328

CLASSIFICAÇÃO FINAL

1 1º

2 2º

3 3º

Mário Augelli 53(USP)

Selma Evangelista 60(SBB)00076

12/09.

15:00h

李宪翔 - Li Xian Xiang 57(AVL)

顾韵 - Gu Yun 61(AVL)

III COPA YAWEN - 2015

SMV II

26

1 李季季 - Lie Tie Tie 54(AVL)

4

BYE

李季季 - Lie Tie Tie 54(AVL)

13/09.

11:00h

4 Mário Augelli 53(USP)

BYE

Mário Augelli 53(USP)

13/09.

14:00h

05 Carlos Kajita 54(ITAPETI)01386

12/09.

17:30h

05 刘以谦 - Liu Yi Qian 50(AVL)

BYE

13/09.

11:00h

José Arioaldo Scudeler 51(HEB)01798

2 José Arioaldo Scudeler 51(HEB)01798

13/09.

14:00h

5 3º

4º

III COPA YAWEN - 2015

DMV II

28

Marco Szabo 53(BUNKA)01562

Chien Erh Wang 49(SPB)00002

12/09.

09:30h

Carlos Kajita 54(ITAPETI)01386

José Arioaldo Scudeler 51(HEB)01798

李季季 - Lie Tie Tie 54(AVL)

刘以谦 - Liu Yi Qian 50(AVL)

12/09.

19:30h

Marco Szabo 53(BUNKA)01562

Chien Erh Wang 49(SPB)00002

CLASSIFICAÇÃO FINAL

1 1º

2 2º

3 3º

Carlos Kajita 54(ITAPETI)01386

José Arioaldo Scudeler 51(HEB)01798

12/09.

12:30h

李季季 - Lie Tie Tie 54(AVL)

刘以谦 - Liu Yi Qian 50(AVL)